



GAS APPLIANCES 2016/17

Exquisite fires for elegant homes

Contents



4-5 **Some things you need to know**



6-7 **Function and Performance**

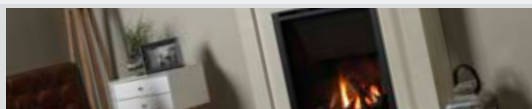

8-9 **HE900 (Standard)**
Glass fronted HE Suite

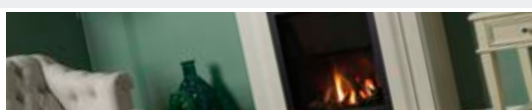

10-11 **HE900 (PCF)**
Glass fronted HE Suite Precast flue



12-13 **Panama**
Glass fronted Widescreen HE



14-15 **Cressida**
Glass fronted Full depth HE



16-17 **Pesaro**
Glass fronted mid-depth HE



18-19 **Thermes**
Balanced Flue

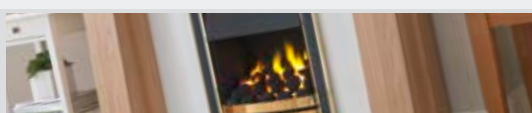

20-21 **Cavello**
Convactor full depth open fronted



22-23 **Montese**
Radiant full depth open fronted



24-25 **Ceralis**
Radiant slimline open fronted



26-27 **Ellipsis**
Radiant full depth open fronted

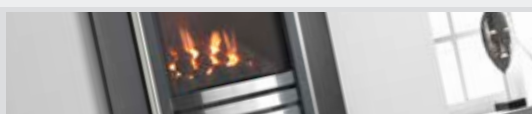

28-29 **Ellipsis HIW**
Hole in the wall gas fires



30-31 **Trim Options & Technical Information**
Trims, frets & other installation specifications



Exquisite fires for elegant homes

At wildfire we are committed to providing the highest quality heating products with a proven performance. Our innovative range of gas appliances have been tested to comply with the latest European standards and are manufactured in an ISO certified factory.

“We guarantee our products for a period of 5 years from installation and our customer service staff are always on hand to help you with any query you may have with your product.”

Our 5 year limited guarantee is managed directly by Wildfire through our extensive network of service centres throughout the UK. Choose Wildfire for style, performance, reliability, value and peace of mind.

The Wildfire product range includes many products which have been designed

and approved with efficiency at their core. In a world where energy costs have soared we believe it is important to obtain the absolute maximum from your heating appliance. With this in mind the net efficiency of Wildfire open fronted gas fires are up to 62% and the glass fronted fires up to 89%. So when you purchase a Wildfire heating product you can be confident that you will be installing a product that will deliver in all installation scenarios. Here at Wildfire we are devoted to innovative design whilst maintaining maximum functionality. All Wildfire slide control products feature the latest patent pending Direct Slide technology.

Wildfire is the premier gas appliance brand from Hearth Products Limited. Hearth Products has been actively involved in design and technology for the fireplace industry across the globe since 2003. our technologies' have been used in products across Europe, Australia and North America.

Some things you need to know

Do I need a Convector or a Radiant Fire?

It is important to know the difference between Radiant heat and Convected heat.

Radiant heat. In short, Radiant heat is emitted from all Wildfire appliances. This type of heat is actually infrared and heats objects in the room. Radiant heat is considered to be the most comfortable and natural form of heat.

Convected heat warms the air in the room. By passing the cooler air which enters the appliance at the bottom, through a heat exchanger, it warms up, then emits the hotter air back into the room from the top of the appliance.

Do I need a Glass Fronted Gas Fire?

A glass fronted fire will be more efficient and therefore more cost effective to run. Glass fronted appliances are generally more expensive to buy

In general terms, it is usually more cost effective to purchase a glass fronted appliance if it is to be used more regularly as the efficiency savings will provide a quicker payback for the more expensive appliance. It is also important to remember that a glass fronted appliance will normally provide a similar amount of heat to an open fronted appliance, however, as it is more efficient, it is cheaper to run.





Brick Chimney



Pre-Fabricated



Pre-Cast

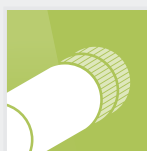

Balanced Flue

What type of flue do I have?

You will need to know what type of flue you have in your home. You will see these icons on each product page which will show if the appliance is suitable for your property. It may be that you have a Brick Chimney (otherwise known as a Class 1 flue), a Pre-Fabricated Metal System (which can be a Class 1 or Class 2 flue) or a Pre-Cast Flue (a flue which is built into the inner brickwork of your home). If you do not have a chimney or flue system in your home then you will need to look for a balanced flue gas fire which, if you already have a balanced flue gas fire in the property, is usually indicated by a flue terminal concealed within a basket on the outside of the property.



Manual Control



Slide Control

Manual
Electronic
Control

What control options are available?

All Wildfire products are available with a Direct Slide option giving you the ease of reliable and simple operation. The slide is operated from the top right side of the appliance and provides ignition, flame control and turns the fire off when you're finished. Most of the Wildfire range is available in manual control too — these fires have a removable cover at the base of the fire where the rotary control and igniter are situated.

Wildfire are also now introducing the manual electronic ignition to make the manual control range even easier to use.



Natural Gas

What type of gas do I need?

Wildfire appliances are currently only available for natural gas.

Function & Performance

O.D.S

The Oxygen Depletion Sensor will automatically shut off the gas supply to the burner if the oxygen level in the room falls below a particular level. This is important as it will turn off the appliance should the flue become blocked or a lack of ventilation occurs.

F.S.D

The Flame Supervision Device is designed to sense the presence of a flame. Should the flame be extinguished for any reason then the safety device will cut off the supply of gas to the burner.

Optional Ezi-Grip Handle

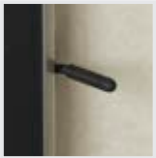

Most Wildfire appliances can be fitted with an elderly/ infirm handle to ease the lighting operation. This larger handle is much easier to access and move so if you think that this may be a requirement then talk to your retailer who will demonstrate the Ezi-Grip system. This handle is purchased as an accessory and is fitted at the point of installation of the appliance.





HE

The Wildfire range is proud to now include a range of glass fronted high efficiency gas fires. These products feature the latest technology in high output gas fires and deliver the most effective way of heating your living room. The range includes both mid-depth convector and full depth convector products, both available with Direct Slide Technology. The Cressida (full depth) appliance can also be installed into a hole in the wall by fitting the designer Ellipsis HIW trim (See pages 28 and 29). The balanced flue gas fire is also a high efficient appliance, for a no chimney solution, the Thermes delivers heat, value for money, efficiency and is available with a large range of trim options.

XE

Open fronted appliances are designed to operate with the revolutionary XE system which is only available from Hearth Products. This new efficiency system is designed to 'tune' the appliance to your fireplace flue, thereby ensuring you obtain the maximum output from the appliance.



Regulations demand that gas fires must be installed by a Registered Gas Safe Engineer. For further information regarding Gas Safe requirements contact Wildfire directly, where we will be happy to give you advice. Warranty will be void if the appliance is not fitted in accordance to these legal requirements.

HE 900 (Standard)

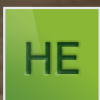

The HE900 featured in the DAWIN SUITE (standard) 52" Mantel in Manila

FLUE OPTIONS



Brick
Chimney



Pre-
Fabricated

CONTROL



Slide

FUEL BED



Log

FUEL



Natural Gas

The HE900 is the flagship model from Wildfire, the ultimate in fireplace technology.

The HE900 gas fire is revolutionary. It has been developed to create a European format appliance with expansive viewing glass that can be installed into a conventional 16" x 22" fireplace opening without any modification. This patent pending product is designed to fit UK fireplace openings with no need to alter the fabric of the building.

The HE900 features a stunning log and ember bed easily controlled with a slide operating system which comes as standard. Finally, the ultimate fireplace solution has arrived...

DIMENSIONS

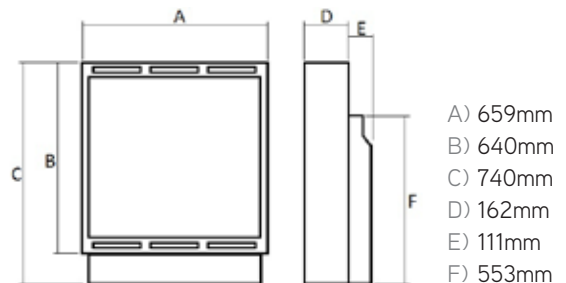

MANTEL DIMENSIONS

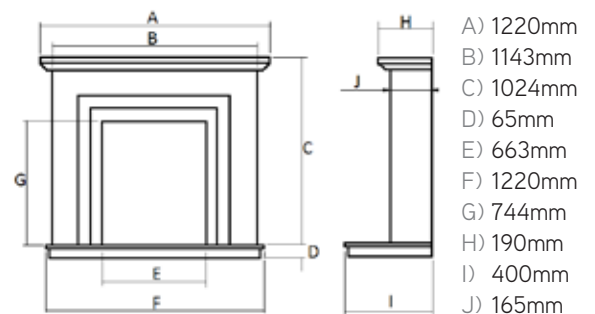

STANDARD MANTEL FINISH OPTIONS



Manila



White

GAS CONSUMPTION

Heat Input (High) **6.75kW**

Heat Input (Low) **3.0kW**

HE 900 (PCF)



HE

The HE900 (PCF) featured in the Dawin Suite (PCF) 52" Mantel in Manila

FLUE OPTIONS



Pre-Cast*

CONTROL



Slide

FUEL BED



Log

FUEL



Natural Gas

The HE900 PCF the sister model to the HE900 with the benefit of fitting into precast flue systems.

No longer are you restricted to choosing a narrow slimline fire for your precast flue. After years of development, innovation and patent applications the precast gas fire market has changed.

Ask your retailer to demonstrate this wonderful appliance, with its clean European styling, stunning log and flame ensemble with easy slide for ignition and control, nothing compares.

The Dawin PCF suite completes this inspirational fireplace the warmest and most welcome addition to your living room. Experience the future with the HE900PCF...

DIMENSIONS

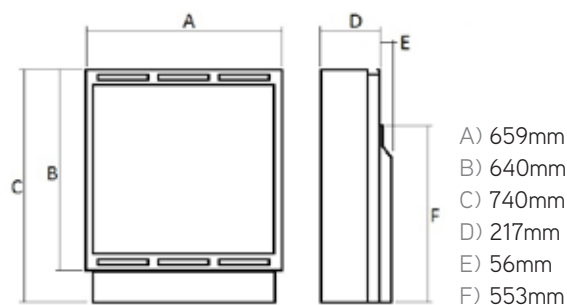

MANTEL DIMENSIONS

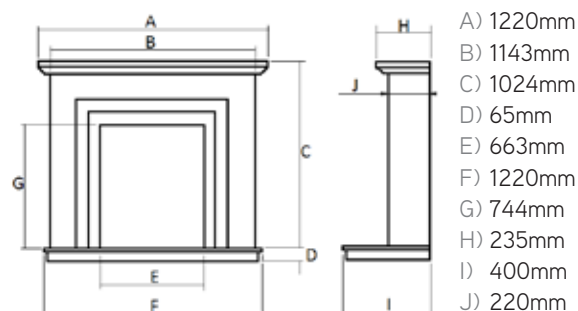

STANDARD MANTEL FINISH OPTIONS

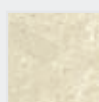

Manila

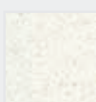

White

GAS CONSUMPTION

Heat Input (High) **6.75kW**

Heat Input (Low) **3.0kW**

Panama HE

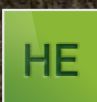

Panama shown with Creative Contemporary Chrome/Black trim.

FLUE OPTIONS



Brick Chimney



Pre-Fabricated

CONTROL



Slide

FUEL BED



Log

FUEL



Natural Gas

CREATIVE TRIM OPTIONS

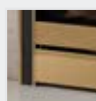

Black/Brass

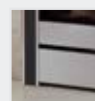

Black/Satin

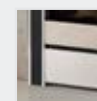

Black/Chrome

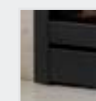

Black

The Panama log fire is a revolutionary product.

This wide format glass fronted gas appliance has the appeal of a European fire but the benefit of fitting into a standard 16" x 22" chimney breast opening. Normally an appliance of this stature would require building work and installation of a new lintel. The Panama has a patent pending installation system which, in conjunction with your new fireplace will provide a much more cost effective solution for this type of product. Talk to your dealer for full details. The Panama comes in slide control as standard.

DIMENSIONS

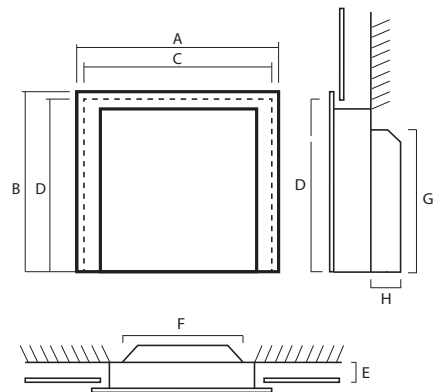

A) 614mm	Trim Width
B) 611mm	Trim Height
C) 560mm-580mm	Back Panel Opening Width
D) 585mm-600mm	Back Panel Opening Height
E) 76mm	Mantel Rebate
F) 406mm	Fire Width at Builders Opening
G) 565mm	Fire Height at Builders Opening
H) 117mm	Fire Depth into Builders Opening

This fire requires a fireplace suite with a 3" rebate and a back panel opening of a specific size. Talk to your retailer for full details.

MANTEL DIMENSIONS

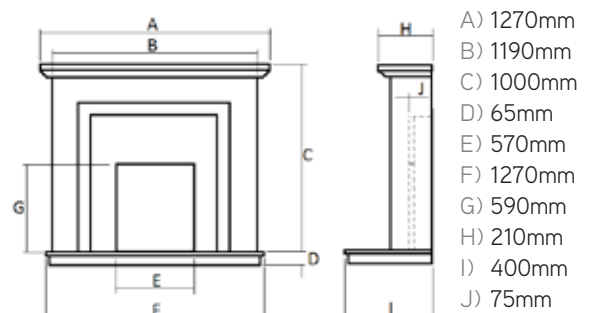

A) 1270mm
B) 1190mm
C) 1000mm
D) 65mm
E) 570mm
F) 1270mm
G) 590mm
H) 210mm
I) 400mm
J) 75mm

SLIDE LEVER OPTIONS



Brass

Chrome

Black

GAS CONSUMPTION

Heat Input (High) 5.5kW

Heat Input (Low) 2.5kW

Cressida HE

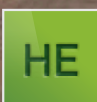

Cressida HE shown with Creative Contemporary Satin/Black trim.

FLUE OPTIONS



Brick Chimney



Pre-Fabricated

CONTROLS



Manual



Slide

FUEL BED



Coal

FUEL



Natural Gas

SLIDE LEVER OPTIONS



Brass



Chrome



Black

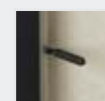

Easy Grip

The Cressida HE is a high efficiency glass fronted appliance suitable for Class 1 and Class 2 flues.

The most powerful gas fire in the Wildfire range, with its deep bed and powerful output this appliance provides the ultimate in performance and style.

The flagship Cressida HE is supplied in either manual or slide control. The slide control features the latest patent pending Direct Slide technology.

Remember, once you have chosen your appliance, you can decide how it looks by selecting trim and fret options. See the trim options below and in more detail on pages 30 and 31.

DIMENSIONS

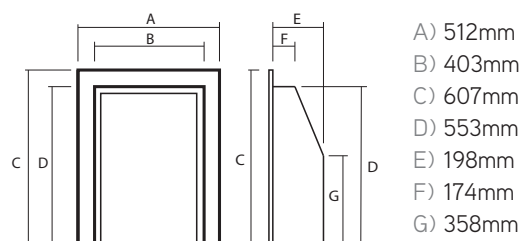

GAS CONSUMPTION

Heat Input (High) 5.5kW

Heat Input (Low) 3kW

STANDARD TRIM OPTIONS

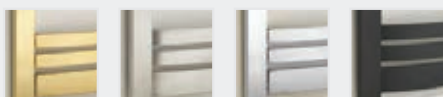

Brass

Satin

Chrome

Black

CREATIVE TRIM OPTIONS

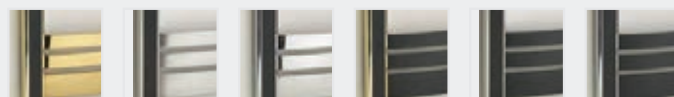

Black/Brass

Black/Satin

Black/Chrome

Black/Brass
Profile

Black/Satin
Profile

Black/Chrome
Profile

Front bars are optional. For more details see pages 30 and 31.

Pesaro HE

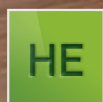

Pesaro HE shown with Chrome Contemporary trim.

FLUE OPTIONS



Brick
Chimney



Pre-
Fabricated

CONTROL



Slide

FUEL BED



Coal

FUEL



Natural Gas

SLIDE LEVER OPTIONS



Brass



Chrome



Black



Easy Grip



The Pesaro HE is a high efficiency glass fronted appliance suitable for Class 1 and Class 2.

When the most important factor is heat, then the Pesaro mid-depth high efficiency gas fire will deliver. The fire can be fitted with an additional spacer to reduce the effective depth of the appliance.

The Pesaro HE is available in slide control as standard.

DIMENSIONS

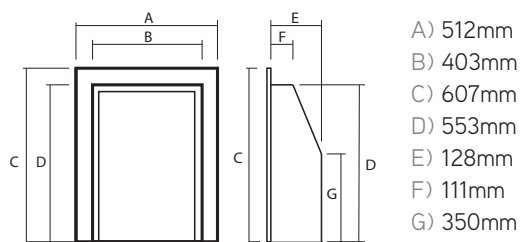

SLIDE LEVER OPTIONS

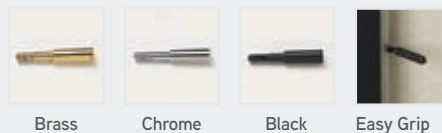

GAS CONSUMPTION

Heat Input (High)	4.3kW
Heat Input (Low)	3kW

STANDARD TRIM OPTIONS

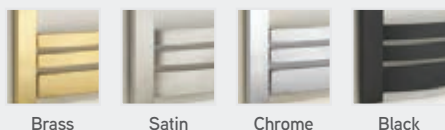

CREATIVE TRIM OPTIONS

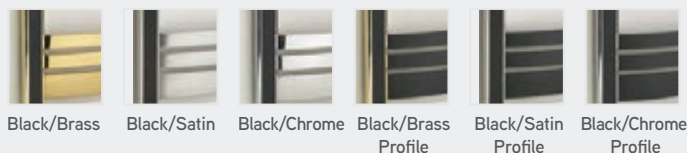

Front bars are optional. For more details see pages 30 and 31.

Thermes

Balanced Flue



HE

Thermes shown with Creative Profile Contemporary Satin/Black trim.

Featured with an Elgin & Hall Sophia 50" surround in Italice Micro Marble

FLUE OPTION



Balanced Flue

CONTROLS



Manual Electronic



Slide

Slide control Available from February 2017

FUEL BED



Coal

FUEL



Natural Gas

*“The balanced flue fire
that really delivers”*

The Thermes is our high efficiency balanced flue gas appliance.

If you have no flue or chimney in your home you will need a balanced flue gas fire. The Thermes is a room sealed high efficiency gas fire that really delivers.

This fire flues through an external wall and can be installed in most new or existing fireplaces.

Remember, once you have chosen your appliance, you can decide how it looks by selecting trim and fret options. See the trim options below and in more detail on pages 30 and 31.

DIMENSIONS

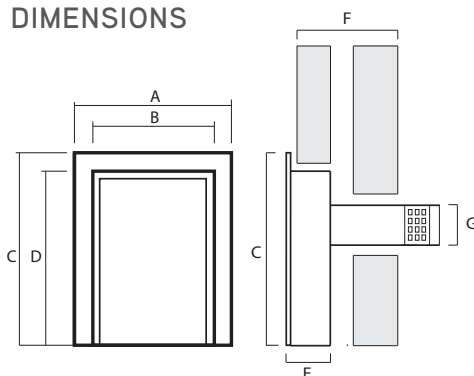

A) 512mm	D) 552mm	G) 152mm
B) 406mm	E) 186mm	
C) 607mm	F) 290-624mm	

GAS CONSUMPTION

Heat Input (High)	4.2kW
Heat Input (Low)	2.9kW

STANDARD TRIM OPTIONS

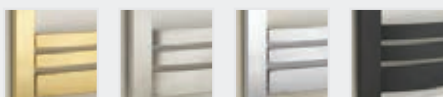

Brass

Satin

Chrome

Black

CREATIVE TRIM OPTIONS

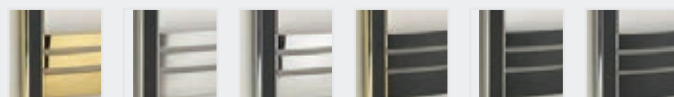

Black/Brass

Black/Satin

Black/Chrome

Black/Brass
ProfileBlack/Satin
ProfileBlack/Chrome
Profile

Front bars are optional. For more details see pages 30 and 31.

Cavello XE



XE

Cavello XE shown with Brass/Black Contemporary Creative trim.

FLUE OPTIONS



Brick
Chimney



Pre-
Fabricated

CONTROLS



Manual



Slide

FUEL BEDS



Coal



Pebble

FUEL



Natural Gas



The Cavello XE is a realistic open fronted gas fire with a powerful convecting heat exchanger to boost performance.

The Cavello is supplied with the XE System as standard, see page 7 for more details. This convector appliance will produce enough heat to satisfy most of the largest living rooms. It is available in manual and slide control with options of coal and pebble fuel bed effects.

The Wildfire Cavello XE can be supplied with a range of trims to suit the style that you are trying to achieve. See full trim options on pages 30 and 31.

DIMENSIONS

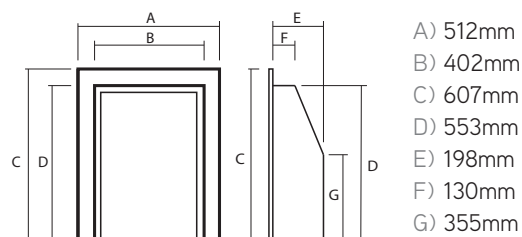

SLIDE LEVER OPTIONS

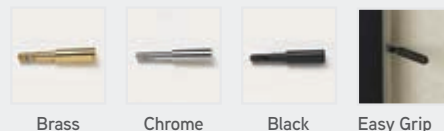

GAS CONSUMPTION

Heat Input (High)	6.75kW
Heat Input (Low)	3kW

STANDARD TRIM OPTIONS

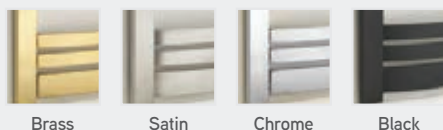

CREATIVE TRIM OPTIONS

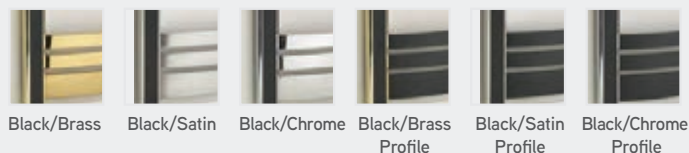

Front bars are optional. For more details see pages 30 and 31.

Montese



XE

The Montese shown with Creative Contemporary Chrome/Black trim. Also shown with XE and pebbles (inset)

FLUE OPTIONS



Brick Chimney



Pre-Fabricated



Pre-Cast

CONTROLS



Manual



Slide

FUEL BEDS



Coal



Pebble

FUEL



Natural Gas

The Montese is a stunning fire that will enhance any living room.

The Montese is an authentic looking coal effect gas fire, where realism is the most important factor.

By utilising the broad range of trims that Wildfire provides, you can choose the mood of your room from contemporary to traditional. It is available with pebble and coal fuel bed options and offers an impressive radiant heat output.

The Wildfire Montese is available in manual and slide control. See pages 30-31 for full trim specifications.

DIMENSIONS

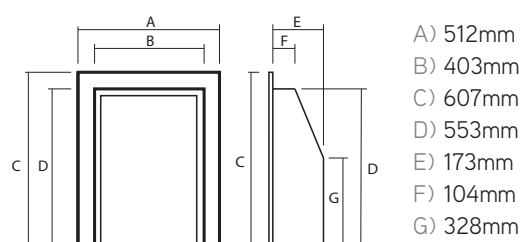

SLIDE LEVER OPTIONS

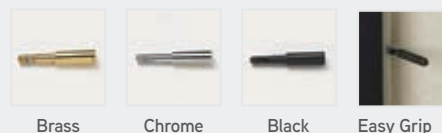

GAS CONSUMPTION

Heat Input (High) **6.75kW**

Heat Input (Low) **3kW**

STANDARD TRIM OPTIONS

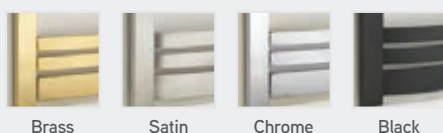

CREATIVE TRIM OPTIONS

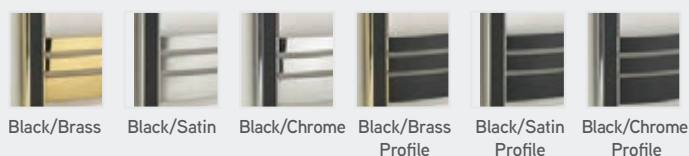

Front bars are optional. For more details see pages 30 and 31.

Ceralis



XE

The Ceralis shown with Standard Brass trim and Brass Bauhaus fret. Also shown with XE and pebbles (inset)

FLUE OPTIONS



Brick Chimney



Pre-Fabricated



Pre-Cast

CONTROLS



Manual



Slide

FUEL BEDS



Coal



Pebble

FUEL



Natural Gas

The Ceralis is a powerful slimline appliance that will fit into all flue types. A spacer is also available to enable it to be fitted into shallow precast flues.

The realistic fuel bed boasts a powerful flame picture for its size making the Wildfire Ceralis the obvious option when the flue available limits your choice of fire.

The Ceralis is available in manual and slide control with coal and pebble fuel bed options. The slimline fire is a stunning appliance which makes it the first choice for your precast flue. For full trim options see pages 30 and 31.

DIMENSIONS

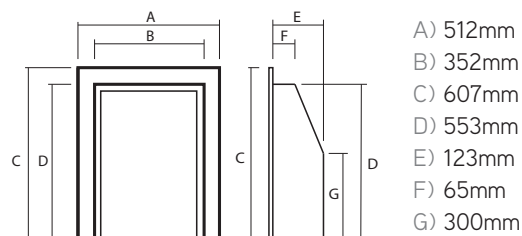

SLIDE LEVER OPTIONS

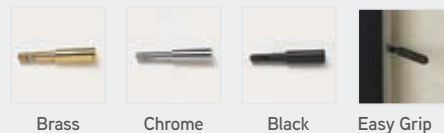

GAS CONSUMPTION

Heat Input (High)	6.75kW
Heat Input (Low)	3kW

STANDARD TRIM OPTIONS

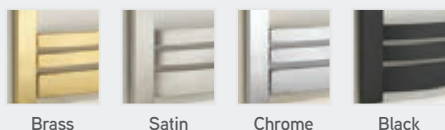

CREATIVE TRIM OPTIONS

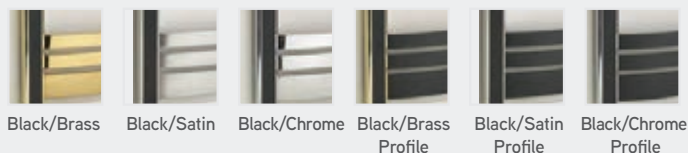

Front bars are optional. For more details see pages 30 and 31.

Ellipsis



HE

Ellipsis Hearth Mounted with Coal and Chrome/Black trim.
Ellipsis HE glass fronted (inset)

FLUE OPTIONS



Brick Chimney



Pre-Fabricated



Pre-Cast*

CONTROL



Manual

FUEL BEDS



Coal



Pebble*

FUEL



Natural Gas

*Open fronted only

This stunning contemporary styled fire will be the focal point in any modern home.

The Ellipsis is available in open fronted or glass fronted HE format. The Ellipsis open fronted has a pebble option. This product is only available as manual control.

The Ellipsis will provide you with a stylish look with flexible installation options.

The Ellipsis Hearth Mounted is also available as a slimline, talk to your retailer for further details.

DIMENSIONS

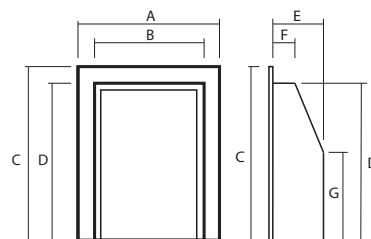

OPEN FRONTED

A) 512mm
B) 403mm
C) 607mm
D) 553mm

GLASS FRONTED

A) 512mm
B) 403mm
C) 607mm
D) 553mm

OPEN FRONTED CONSUMPTION

Heat Input (High) 6.75kW

Heat Input (Low) 3kW

GLASS FRONTED CONSUMPTION

Heat Input (High) 5.5kW

Heat Input (Low) 3kW

ELLIPSIS TRIM OPTIONS

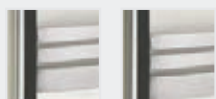

Satin/Black Chrome/Black

Ellipsis HIW



The Ellipsis 'Hole in the wall' with Chrome/Black trim. Open fronted in pebble (inset)

FLUE OPTIONS



Brick Chimney



Pre-Fabricated



Balanced Flue

Balanced Flue Dimensions see page 19.

CONTROL



Manual

FUEL BEDS



Coal



Pebble*

FUEL



Natural Gas

*Open fronted only

This beautifully styled hole in the wall appliance produces a powerful output.

Its warmth will transform your living environment. The Ellipsis is suitable for Class 1 and Class 2 flue types and is available in Coal or Pebble.*

The Ellipsis is available in open fronted or glass fronted HE format. The Ellipsis open fronted has a pebble option. This product is only available as manual control.

The Wildfire Ellipsis combines style, efficiency and space saving to provide the ultimate solution for an open fronted gas or glass fronted fire. If you are looking for realism coupled with powerful heat whilst retaining efficiency then this is the product for you.

DIMENSIONS

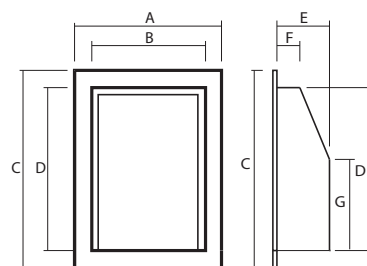

GLASS FRONTED

A) 512mm
B) 403mm
C) 660mm
D) 553mm

OPEN FRONTED

A) 512mm
B) 403mm
C) 660mm
D) 553mm

GLASS FRONTED CONSUMPTION

Heat Input (High) 5.5kW

Heat Input (Low) 3kW

OPEN FRONTED CONSUMPTION

Heat Input (High) 6.75kW

Heat Input (Low) 3kW

ELLIPSIS TRIM OPTIONS



4 Sided Satin/Black 4 Sided Chrome/Black

Trim Options

Choose the trim and fret options from the selection on this page. The Standard and Creative trim and fret options will fit **ALL** of the products in this brochure. The Ellipsis trim will fit manual control fires only. For further fret options consult your retailer.

SLIDE LEVER OPTIONS



Brass



Chrome



Black

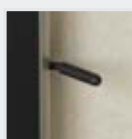

Easy Grip

STANDARD TRIM OPTIONS



Brass



Satin



Chrome



Black



Contemporary Brass



Contemporary Satin



Contemporary Chrome



Contemporary Black

CREATIVE TRIM OPTIONS



Brass/Black

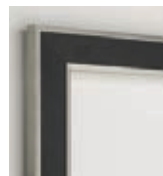

Satin/Black



Chrome/Black

Contemporary
Brass/BlackContemporary
Satin/BlackContemporary
Chrome/Black

PROFILE TRIM OPTIONS

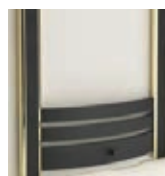
Black/Brass
ProfileBlack/Satin
ProfileBlack/Chrome
Profile

ELLIPSIS TRIM OPTIONS



Satin/Black



Chrome/Black



4 Sided Satin/Black



4 Sided Chrome/Black

Ellipsis trim only suitable for manual control appliances

PANAMA TRIM OPTIONS

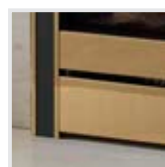

Black/Brass



Black/Satin



Black/Chrome



Black





Technical Information

Use the chart below to quickly check the options available for each product contained in this brochure. You will also find the flue types which products can be installed into. For further information consult the manufacturers installation instructions or ask your local retailer for further advice.

PAGE NO.	FIRES	COAL OPTION	PEBBLE OPTION	LOG OPTION	MANUAL CONTROL	SLIDE CONTROL	PRE-CAST FLUE	CLASS II FLUE	CLASS I FLUE	BALANCED FLUE	XE INCLUDED	XE OPTIONAL	HE
8-9	HE900 (STD)			✓		✓		✓	✓				✓
10-11	HE900 (PCF)			✓		✓	✓						✓
12-13	PANAMA			✓		✓		✓	✓				✓
14-15	CRESSIDA HE	✓			✓	✓		✓	✓				✓
16-17	PESARO HE	✓				✓		✓	✓				✓
18-19	THERMES	✓			✓	✓ [†]				✓			✓
20-21	CAVELLO XE	✓	✓		✓	✓		✓	✓		✓		
22-23	MONTESE	✓	✓		✓	✓	✓	✓	✓			✓	
24-25	CERALIS	✓	✓		✓	✓	✓	✓	✓			✓	
26-27	ELLIPSIS	✓	✓*		✓			✓	✓			✓	✓**
28-29	ELLIPSIS HIW	✓	✓*		✓			✓	✓			✓	✓**

*open fronted only **glass fronted only †available from Feb 2017

WILDFIRE
SPREADING INNOVATION



HEARTH PRODUCTS

Sales Enquiries: sales@hearthproducts.co.uk

Technical Enquiries: customerservice@hearthproducts.co.uk

Tel: 01785 225401 | **Fax:** 01785 225501

Hearth Products Ltd, Unit 14 Brindley Close,
Tollgate Industrial Estate, Stafford ST16 3SU

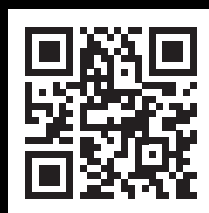

www.hearthproducts.co.uk

Scan the QR code with your mobile device to be directed
to the Hearth Products Website.



WILD



FIRE

